

SMC Super Fast Recovery Diode 特快恢复二极管

■ Features 特点

High current capability 高电流能力
Low forward voltage drop 低正向压降
Super Fast Recovery time 特快恢复时间
Surface mount device 表面贴装器件
Case 封装:SMC

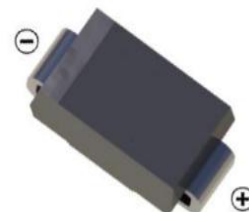

■ Maximum Rating 最大额定值

($T_A=25^{\circ}\text{C}$ unless otherwise noted 如无特殊说明, 温度为 25°C)

Characteristic 特性参数	Symbol 符号	US5A	US5B	US5D	US5G	US5J	US5K	US5M	Unit 单位
Repetitive Peak Reverse Voltage 重复峰值反向电压	V_{RRM}	50	100	200	400	600	800	1000	V
DC Reverse Voltage 直流反向电压	V_R	50	100	200	400	600	800	1000	V
RMS Reverse Voltage 反向电压均方根值	$V_{R(RMS)}$	35	70	140	280	420	560	700	V
Forward Rectified Current 正向整流电流	I_F	5							A
Peak Surge Current 峰值浪涌电流	I_{FSM}	120							A
Thermal Resistance J-A 结到环境热阻	$R_{\theta JA}$	30							$^{\circ}\text{C}/\text{W}$
Junction/Storage Temperature 结温/储藏温度	T_J, T_{stg}	-50to+150 $^{\circ}\text{C}$							$^{\circ}\text{C}$

■ Electrical Characteristics 电特性

($T_A=25^{\circ}\text{C}$ unless otherwise noted 如无特殊说明, 温度为 25°C)

Characteristic 特性参数	Symbol 符号	US5A-US5D	US5G	US5J-US5M	Unit 单位	Condition 条件
Forward Voltage 正向电压	V_F	1.0	1.3	1.7	V	$I_F=5\text{A}$
Reverse Current 反向电流	I_R	10($T_A=25^{\circ}\text{C}$) 200($T_A=100^{\circ}\text{C}$)			μA	$V_R=V_{RRM}$
Reverse Recovery Time 反向恢复时间	T_{rr}	50		75	nS	$I_F=0.5\text{A}, I_R=1\text{A}$ $I_{rr}=0.25\text{A}$
Junction Capacitance 结电容	C_J	75			pF	$V_R=4\text{V}, f=1\text{MHz}$

■ Typical Characteristic Curve 典型特性曲线

FIG.1 - TEST CIRCUIT DIAGRAM AND REVERSE RECOVERY TIME CHARACTERISTIC

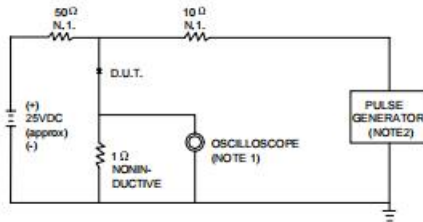

NOTES:1.RISE TIME = 7ns MAX.INPUT IMPEDANCE = 1MΩ.22pF.
2.RISE TIME = 10ns MAX.SOURCE IMPEDANCE=50 Ω.

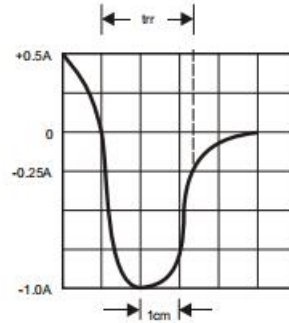

FIG.2 -- TYPICAL FORWARD CHARACTERISTIC

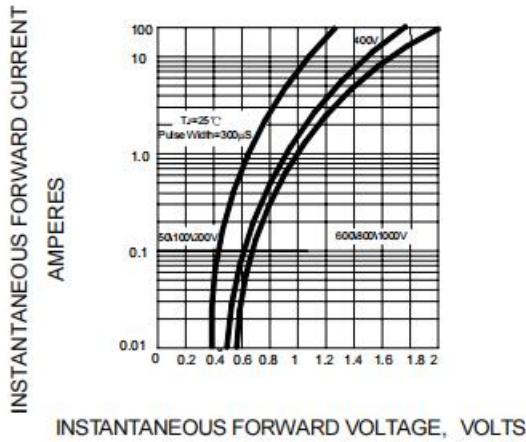

FIG.3 -- FORWARD DERATING CURVE

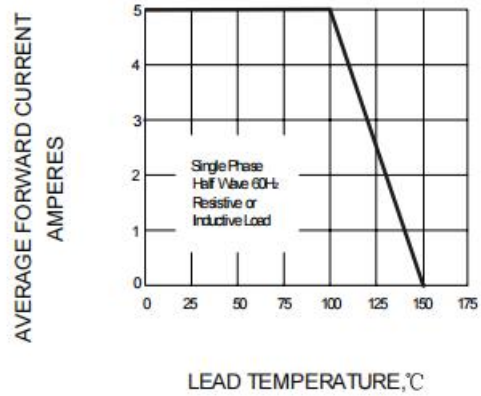

FIG.4 -- TYPICAL JUNCTION CAPACITANCE

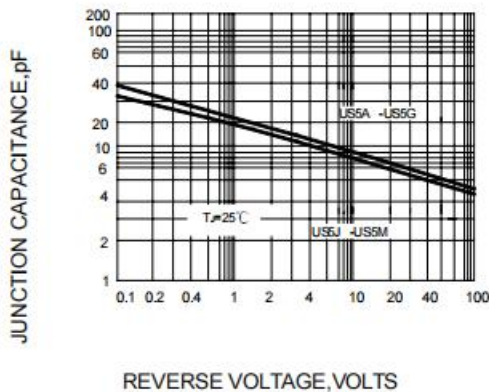
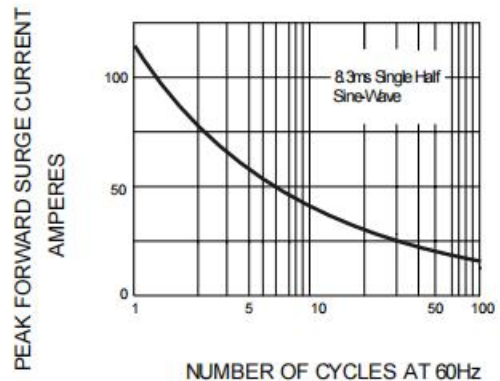
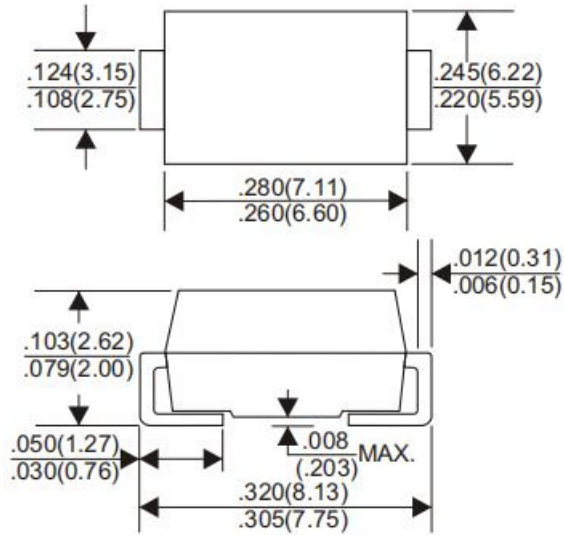

FIG.5 -- PEAK FORWARD SURGE CURRENT



■Dimension 外形封装尺寸

DO-214AB(SMC)



Dimensions in inches and (millimeters)