

**PDFN3.3X3.3-8 N Channel Enhancement 沟道增强型  
MOS Field Effect Transistor 场效应管**

**■ Features 特点**

Low on-resistance 低导通电阻  
 $R_{DS(ON)}=16m\Omega(\text{Type})@V_{GS}=10V$   
 $R_{DS(ON)}=21m\Omega(\text{Type})@V_{GS}=4.5V$

**■ Applications 应用**

Load Switch 负载开关  
 Portable Equipment 桌面设备  
 Power Management 电源管理

**■ Internal Schematic Diagram 内部结构**

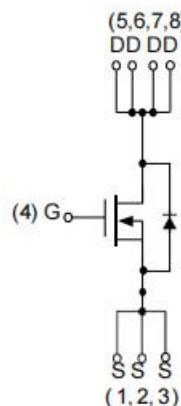
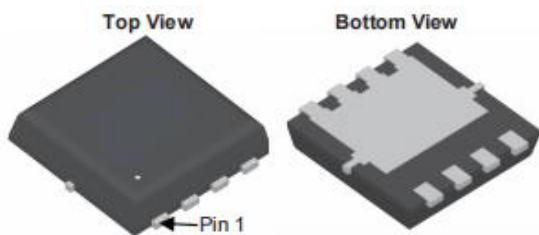

**■ Absolute Maximum Ratings 最大额定值**

Characteristic 特性参数	Symbol 符号	Rat 额定值	Unit 单位
Drain-Source Voltage 漏极-源极电压	$BV_{DSS}$	30	V
Gate- Source Voltage 栅极-源极电压	$V_{GS}$	$\pm 20$	V
Drain Current (continuous)漏极电流-连续	$I_D$ (at $T_C = 25^\circ C$ at $T_A = 25^\circ C$ )	23 8	A
Drain Current (pulsed)漏极电流-脉冲	$I_{DM}$	28	A
Total Device Dissipation 总耗散功率	$P_{TOT}$ (at $T_C = 25^\circ C$ at $T_A = 25^\circ C$ )	17.8 1.56	W
Avalanche Energy(Single Pulse)雪崩能量	$E_{AS}$	12	mJ
Thermal Resistance Junction-Ambient 热阻	$R_{\theta JC}/R_{\theta JA}$	7/80	$^\circ C/W$
Junction/Storage Temperature 结温/储存温度	$T_J, T_{stg}$	-55~150	$^\circ C$

■ **Electrical Characteristics 电特性**

( $T_A=25^{\circ}\text{C}$  unless otherwise noted 如无特殊说明, 温度为  $25^{\circ}\text{C}$ )

Characteristic 特性参数	Symbol 符号	Min 最小值	Typ 典型值	Max 最大值	Unit 单位
Drain-Source Breakdown Voltage 漏极-源极击穿电压( $I_D=250\mu\text{A}, V_{GS}=0\text{V}$ )	$BV_{DSS}$	30	—	—	V
Gate Threshold Voltage 栅极开启电压( $I_D=250\mu\text{A}, V_{GS}=V_{DS}$ )	$V_{GS(th)}$	1.4	1.8	2.5	V
Zero Gate Voltage Drain Current 零栅压漏极电流( $V_{GS}=0\text{V}, V_{DS}=24\text{V}$ )	$I_{DSS}$	—	—	1	$\mu\text{A}$
Gate Body Leakage 栅极漏电流( $V_{GS}=\pm 20\text{V}, V_{DS}=0\text{V}$ )	$I_{GSS}$	—	—	$\pm 100$	nA
Static Drain-Source On-State Resistance 静态漏源导通电阻( $I_D=8\text{A}, V_{GS}=10\text{V}$ ) ( $I_D=5\text{A}, V_{GS}=4.5\text{V}$ )	$R_{DS(ON)}$	—	16 21	21 26	$\text{m}\Omega$
Diode Forward Voltage Drop 内附二极管正向压降( $I_{SD}=1\text{A}, V_{GS}=0\text{V}$ )	$V_{SD}$	—	0.75	1.1	V
Input Capacitance 输入电容 ( $V_{GS}=0\text{V}, V_{DS}=15\text{V}, f=1\text{MHz}$ )	$C_{ISS}$	—	415	—	pF
Common Source Output Capacitance 共源输出电容( $V_{GS}=0\text{V}, V_{DS}=15\text{V}, f=1\text{MHz}$ )	$C_{OSS}$	—	70	—	pF
Reverse Transfer Capacitance 反馈电容 ( $V_{GS}=0\text{V}, V_{DS}=15\text{V}, f=1\text{MHz}$ )	$C_{RSS}$	—	40	—	pF
Total Gate Charge 栅极电荷密度 ( $V_{DS}=15\text{V}, I_D=8\text{A}, V_{GS}=4.5\text{V}$ )	$Q_g$	—	8	—	nC
Gate Source Charge 栅源电荷密度 ( $V_{DS}=15\text{V}, I_D=8\text{A}, V_{GS}=4.5\text{V}$ )	$Q_{gs}$	—	2	—	nC
Gate Drain Charge 栅漏电荷密度 ( $V_{DS}=15\text{V}, I_D=8\text{A}, V_{GS}=4.5\text{V}$ )	$Q_{gd}$	—	3	—	nC
Turn-ON Delay Time 开启延迟时间 ( $V_{DS}=15\text{V}, I_D=1\text{A}, R_{GEN}=6\Omega, V_{GS}=10\text{V}$ )	$t_{d(on)}$	—	6	—	ns
Turn-ON Rise Time 开启上升时间 ( $V_{DS}=15\text{V}, I_D=1\text{A}, R_{GEN}=6\Omega, V_{GS}=10\text{V}$ )	$t_r$	—	9	—	ns
Turn-OFF Delay Time 关断延迟时间 ( $V_{DS}=15\text{V}, I_D=1\text{A}, R_{GEN}=6\Omega, V_{GS}=10\text{V}$ )	$t_{d(off)}$	—	14	—	ns
Turn-OFF Fall Time 关断下降时间 ( $V_{DS}=15\text{V}, I_D=1\text{A}, R_{GEN}=6\Omega, V_{GS}=10\text{V}$ )	$t_f$	—	4	—	ns

■ Typical Characteristic Curve 典型特性曲线

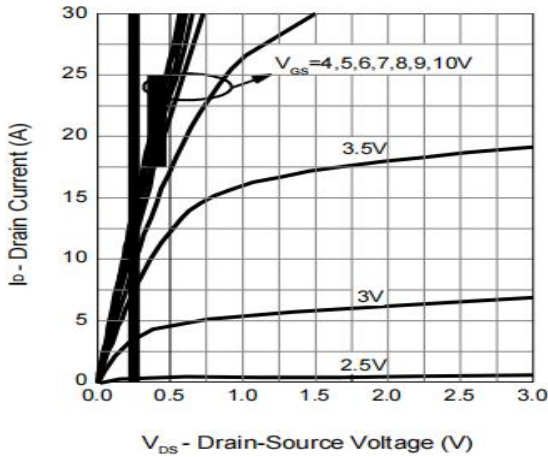

Figure 1: Output Characteristics

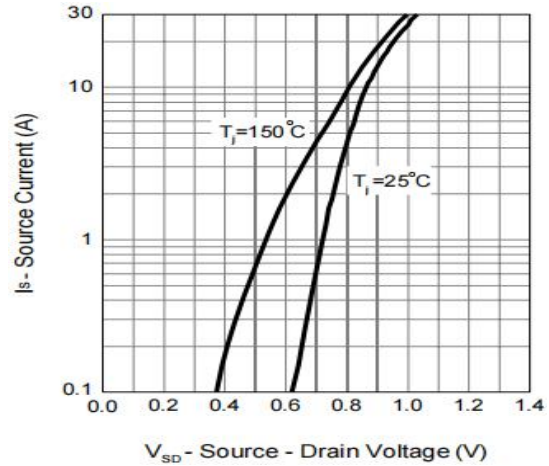

Figure 2: Diode Forward Characteristics

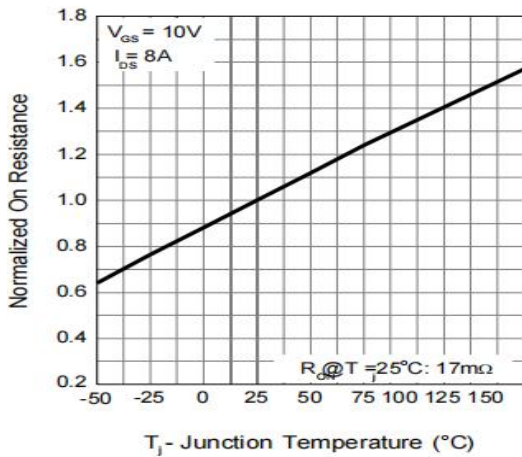

Figure 3: On-Resistance vs.  $T_J$

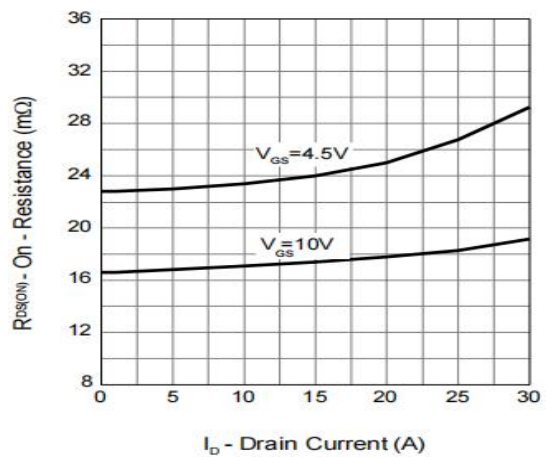

Figure 4: On-Resistance vs. Drain Current

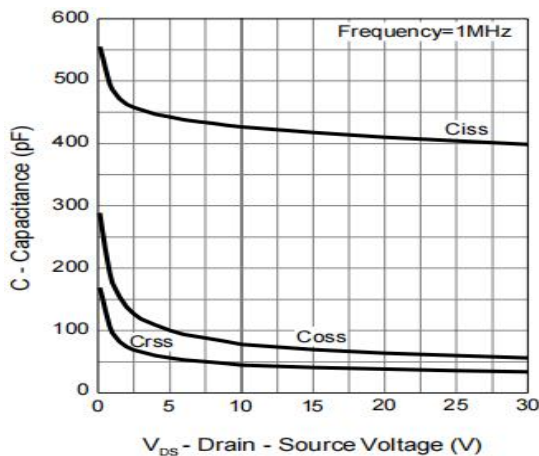

Figure 5: Capacitance Characteristics

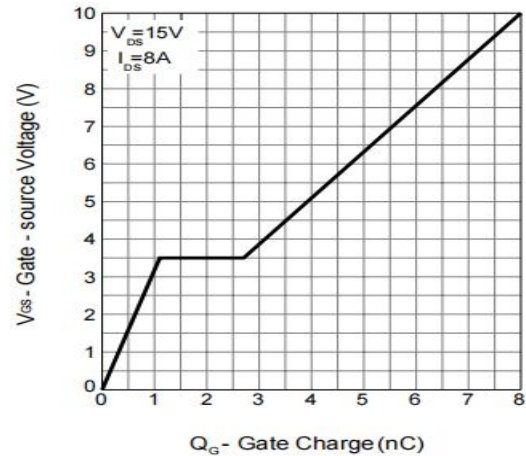

Figure 6: Gate-Charge Characteristics

■ Typical Characteristic Curve 典型特性曲线

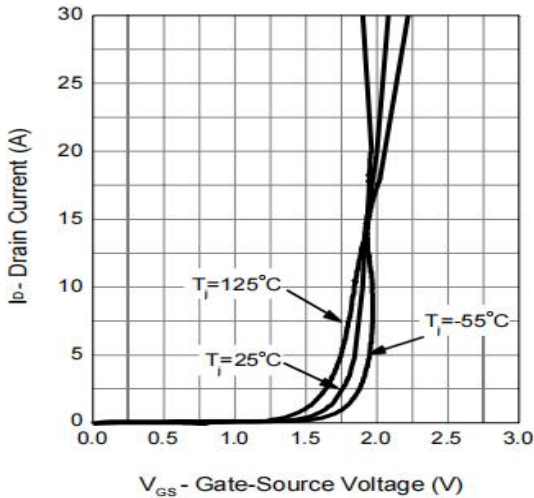

Figure 7: Transfer Characteristics

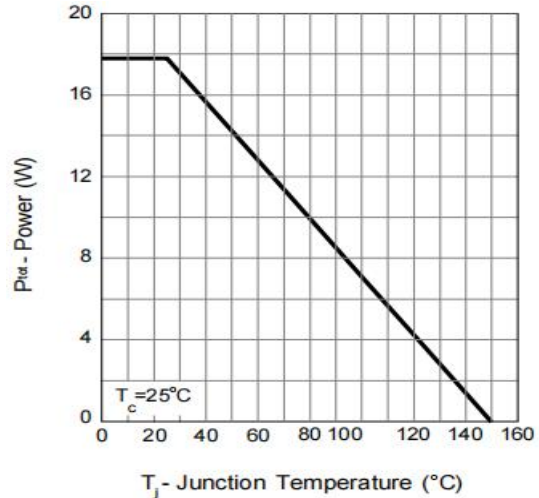

Figure 8: Power Rating Curve

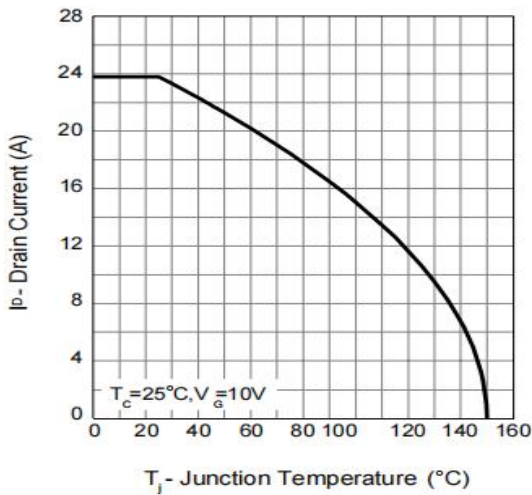

Figure 9: Drain Current Characteristics

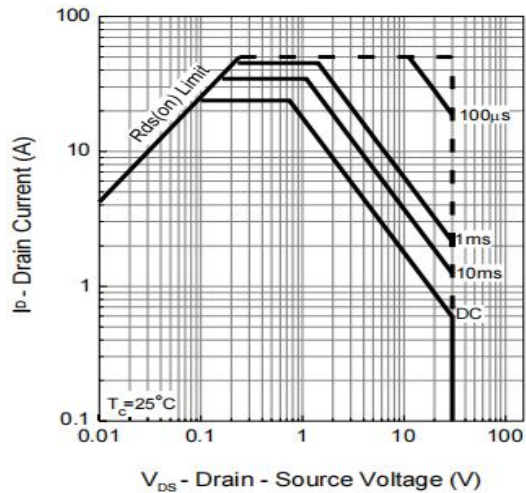

Figure 10: Safe Operating Area

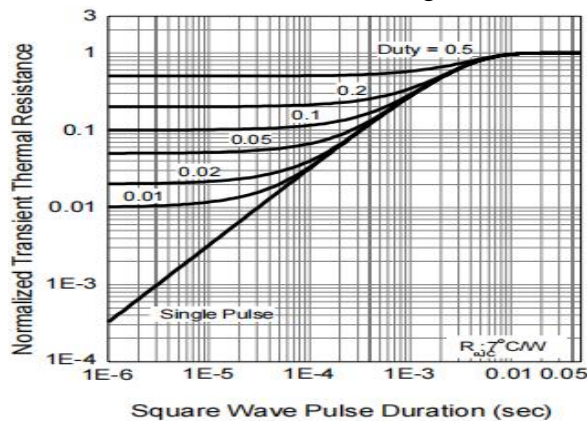
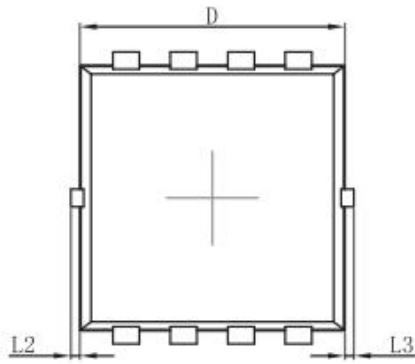
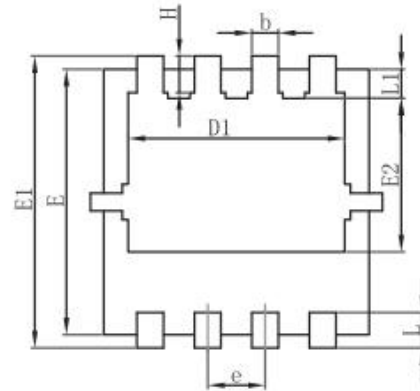

Figure 11: Transient Thermal Response Curve

■ Dimension 外形封装尺寸



Top View



Bottom View

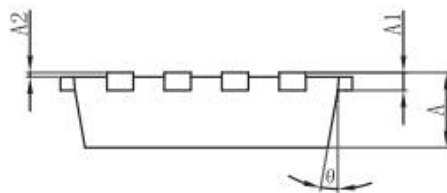

Side View

Symbol	Dimensions In Millimeters		Dimensions In Inches	
	Min.	Max.	Min.	Max.
A	0.650	0.850	0.026	0.033
A1	0.152 REF.		0.006 REF.	
A2	0~0.05		0~0.002	
D	2.900	3.100	0.114	0.122
D1	2.300	2.600	0.091	0.102
E	2.900	3.100	0.114	0.122
E1	3.150	3.450	0.124	0.136
E2	1.535	1.935	0.060	0.076
b	0.200	0.400	0.008	0.016
e	0.550	0.750	0.022	0.030
L	0.300	0.500	0.012	0.020
L1	0.180	0.480	0.007	0.019
L2	0~0.100		0~0.004	
L3	0~0.100		0~0.004	
H	0.315	0.515	0.012	0.020
θ	9°	13°	9°	13°