

**TO-252 N Channel Enhancement 沟道增强型
MOS Field Effect Transistor 场效应管**

■ **Features 特点**

Low on-resistance 低导通电阻
 $R_{DS(ON)}=85m\Omega(\text{Type})@V_{GS}=10V$
 $R_{DS(ON)}=96m\Omega(\text{Type})@V_{GS}=4.5V$

■ **Applications 应用**

Backlight Drive 背光驱动
 DC-DC Conversion 升压转换
 Power Management 电源管理

■ **Internal Schematic Diagram 内部结构**

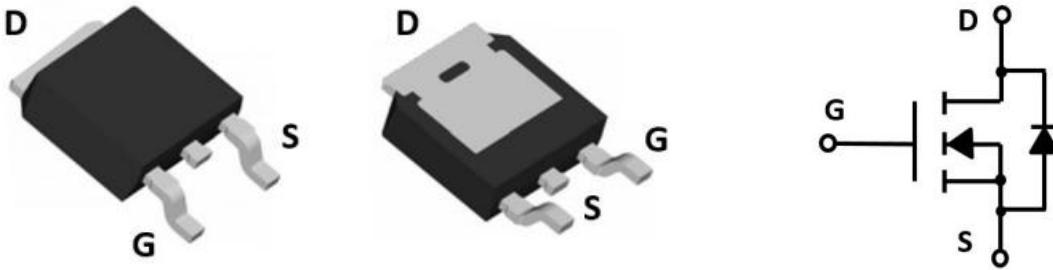

■ **Absolute Maximum Ratings 最大额定值**

Characteristic 特性参数	Symbol 符号	Rat 额定值	Unit 单位
Drain-Source Voltage 漏极-源极电压	BV_{DSS}	100	V
Gate- Source Voltage 栅极-源极电压	V_{GS}	± 20	V
Drain Current (continuous)漏极电流-连续	I_D (at $T_C = 25^\circ C$ at $T_A = 25^\circ C$)	15 3	A
Drain Current (pulsed)漏极电流-脉冲	I_{DM}	20	A
Total Device Dissipation 总耗散功率	P_{TOT} (at $T_C = 25^\circ C$ at $T_A = 25^\circ C$)	30 2	W
Thermal Resistance Junction-Case/Ambient 热阻	$R_{\theta JC}/R_{\theta JA}$	4.2/62	$^\circ C/W$
Avalanche Energy Single Pulse 雪崩能量	E_{AS}	6.1	mJ
Junction/Storage Temperature 结温/储存温度	T_J, T_{stg}	-55~150	$^\circ C$

■ Electrical Characteristics 电特性

($T_A=25^{\circ}\text{C}$ unless otherwise noted 如无特殊说明, 温度为 25°C)

Characteristic 特性参数	Symbol 符号	Min 最小值	Typ 典型值	Max 最大值	Unit 单位
Drain-Source Breakdown Voltage 漏极-源极击穿电压($I_D=250\mu\text{A}, V_{GS}=0\text{V}$)	BV_{DSS}	100	—	—	V
Gate Threshold Voltage 栅极开启电压($I_D=250\mu\text{A}, V_{GS}=V_{DS}$)	$V_{GS(th)}$	1.0	1.5	2.5	V
Zero Gate Voltage Drain Current 零栅压漏极电流($V_{GS}=0\text{V}, V_{DS}=100\text{V}$)	I_{DSS}	—	—	1	μA
Gate Body Leakage 栅极漏电流($V_{GS}=\pm 20\text{V}, V_{DS}=0\text{V}$)	I_{GSS}	—	—	± 100	nA
Static Drain-Source On-State Resistance 静态漏源导通电阻($I_D=5\text{A}, V_{GS}=10\text{V}$) ($I_D=3\text{A}, V_{GS}=4.5\text{V}$)	$R_{DS(ON)}$	—	85 96	110 140	$\text{m}\Omega$
Diode Forward Voltage Drop 内附二极管正向压降($I_{SD}=10\text{A}, V_{GS}=0\text{V}$)	V_{SD}	—	0.8	1.2	V
Input Capacitance 输入电容 ($V_{GS}=0\text{V}, V_{DS}=25\text{V}, f=1\text{MHz}$)	C_{ISS}	—	765	—	pF
Common Source Output Capacitance 共源输出电容($V_{GS}=0\text{V}, V_{DS}=25\text{V}, f=1\text{MHz}$)	C_{OSS}	—	38	—	pF
Reverse Transfer Capacitance 反馈电容 ($V_{GS}=0\text{V}, V_{DS}=25\text{V}, f=1\text{MHz}$)	C_{RSS}	—	33	—	pF
Total Gate Charge 栅极电荷密度 ($V_{DS}=50\text{V}, I_D=2\text{A}, V_{GS}=10\text{V}$)	Q_g	—	18	—	nC
Gate Source Charge 栅源电荷密度 ($V_{DS}=50\text{V}, I_D=2\text{A}, V_{GS}=10\text{V}$)	Q_{gs}	—	2.5	—	nC
Gate Drain Charge 栅漏电荷密度 ($V_{DS}=50\text{V}, I_D=2\text{A}, V_{GS}=10\text{V}$)	Q_{gd}	—	4	—	nC
Turn-ON Delay Time 开启延迟时间 ($V_{DS}=50\text{V}, I_D=3\text{A}, R_{GEN}=1.8\Omega, V_{GS}=10\text{V}$)	$t_{d(on)}$	—	7.5	—	ns
Turn-ON Rise Time 开启上升时间 ($V_{DS}=50\text{V}, I_D=3\text{A}, R_{GEN}=1.8\Omega, V_{GS}=10\text{V}$)	t_r	—	6	—	ns
Turn-OFF Delay Time 关断延迟时间 ($V_{DS}=50\text{V}, I_D=3\text{A}, R_{GEN}=1.8\Omega, V_{GS}=10\text{V}$)	$t_{d(off)}$	—	21	—	ns
Turn-OFF Fall Time 关断下降时间 ($V_{DS}=50\text{V}, I_D=3\text{A}, R_{GEN}=1.8\Omega, V_{GS}=10\text{V}$)	t_f	—	9	—	ns

■ Typical Characteristic Curve 典型特性曲线

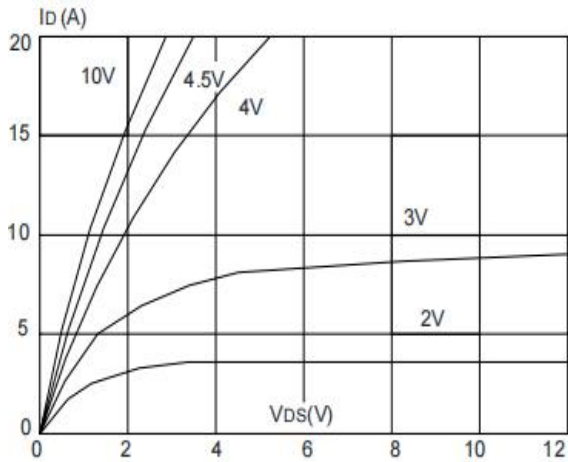

Figure 1: Output Characteristics

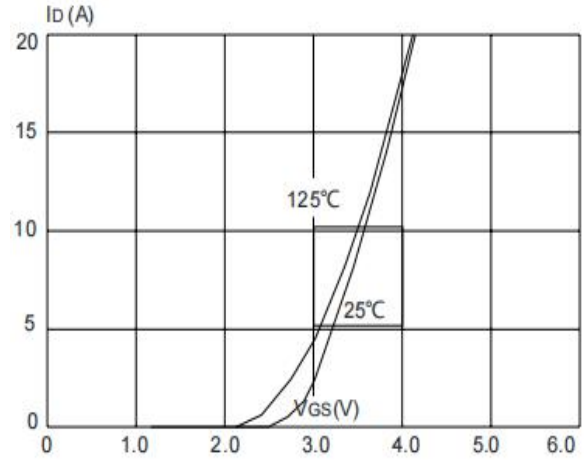

Figure 2: Transfer Characteristics

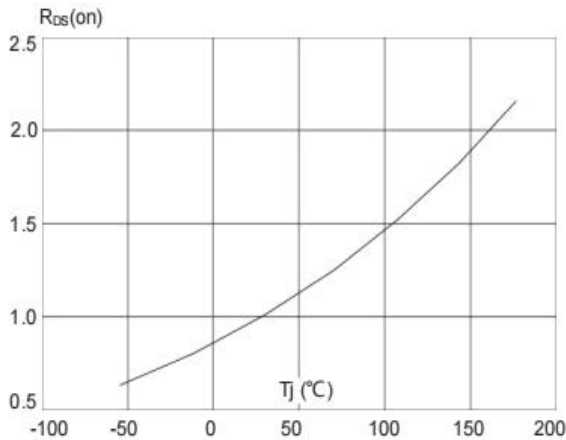

Figure 3: On-Resistance vs. T_J

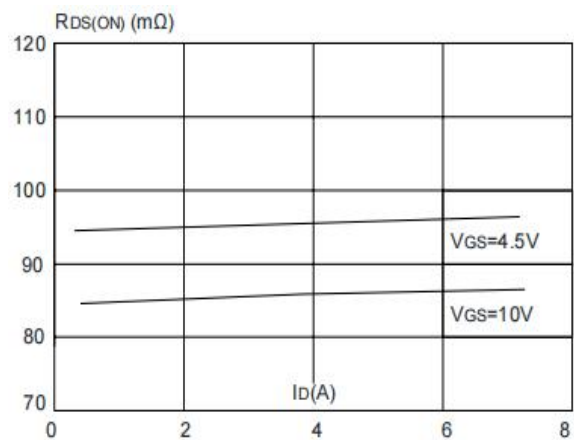

Figure 4: On-Resistance vs. Drain Current

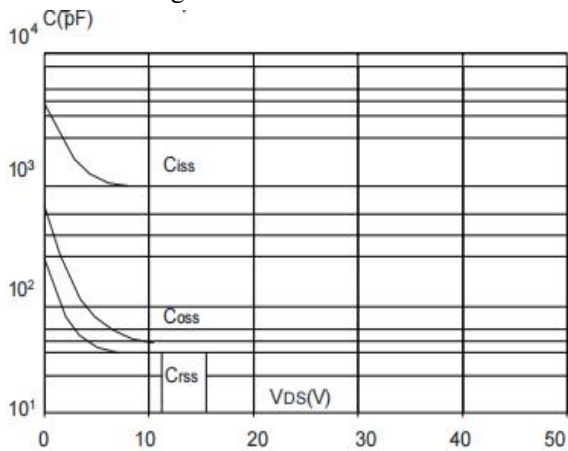

Figure 5: Capacitance Characteristics

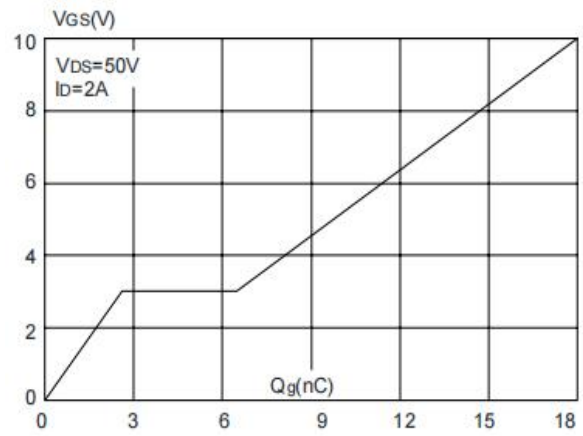

Figure 6: Gate-Charge Characteristics

■ Typical Characteristic Curve 典型特性曲线

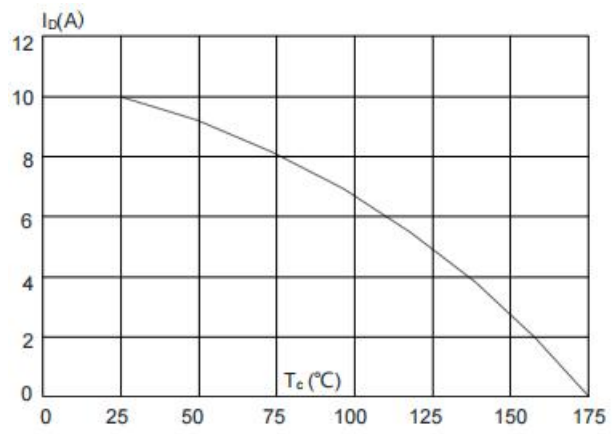

Figure 7: Drain Current Characteristics

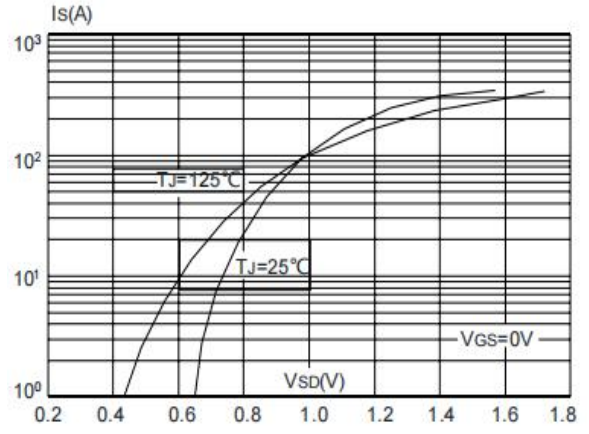

Figure 8: Body Diode Characteristics

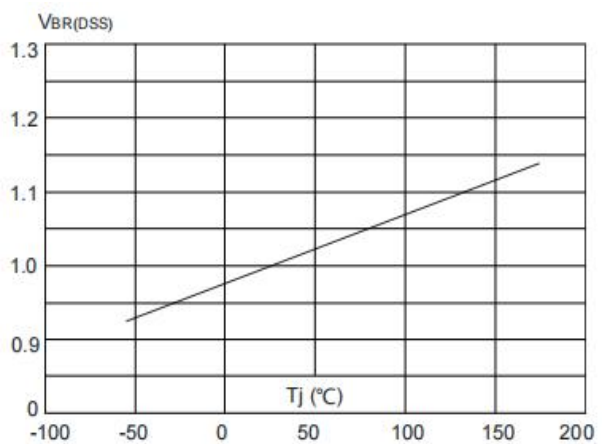

Figure 9: Breakdown Voltage vs. T_j

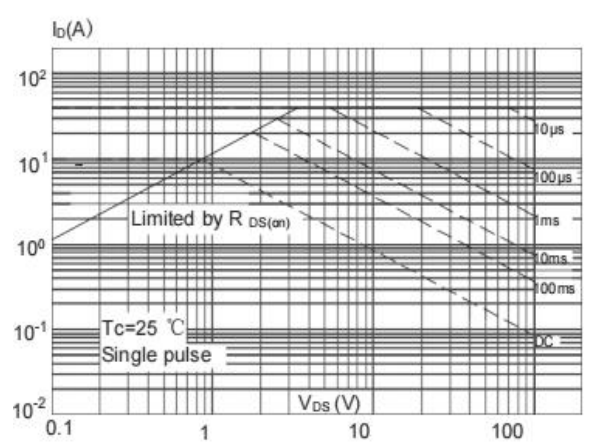

Figure 10: Safe Operating Area

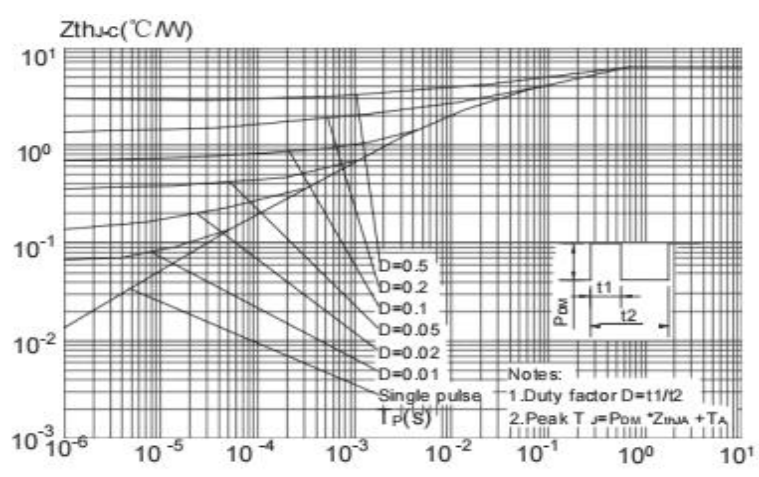
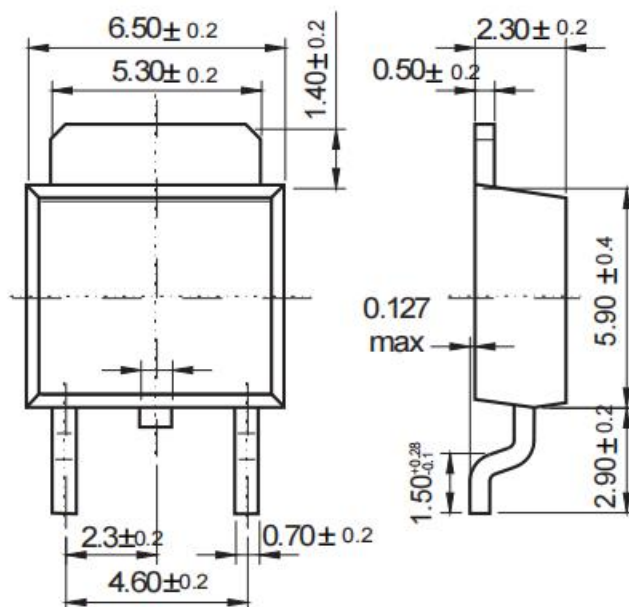

Figure 11: Transient Thermal Response Curve

■ Dimension 外形封装尺寸

TO-252

Unit: mm



Dimensions in inches and (millimeters)